



NATURE COLLECTION



THE WARMTH YOU FEEL

WARM ALUMINUM CONSTRUCTION

PROTECTION AGAINST DRAFTS, FREEZING, AND CONDENSATION

ENERGY-EFFICIENT TRIPLEX GLASS UNITS

ENERGY-EFFICIENT TRIPLEX GLASS UNITS

THE RELIABILITY YOU NEED

ALUMINUM CAN WITHSTAND HIGH LOADS AND RESIST DEFORMATION

THE FINISH RETAINS ITS ORIGINAL APPEARANCE FOR MANY YEARS

SHOCKPROOF TRIPLEX GLASS UNITS

DOORS WITHSTAND HEAVY LOADS AND RESIST DEFORMATION





STANDS FOR IMPRESSIVE DURABILITY

RELIABLE ALUMINUM CONSTRUCTION IS RESISTANT TO
INTENSIVE USE AND TEMPERATURE FLUCTUATIONS

POLIMEX AND DECOLUX FINISHES COME WITH A 10-YEAR WARRANTY

THOUGHT-OUT CONSTRUCTION IS BASED ON MANY YEARS
OF OUR EXPERIENCE

STAINLESS STEEL HARDWARE COMES WITH A 10-YEAR WARRANTY



OFFERS LIMITLESS POSSIBILITIES

ENTRANCE GROUPS OF NON-STANDARD DIMENSIONS

PANORAMIC GLAZING WITH TRIPLEX GLASS UNITS

CUSTOM DESIGN AND VARIETY OF SHADES

SMART LOCKS FOR MAXIMUM COMFORT

AG6096 P-SU



AG6003 P-SU



AG6155 P-SU



AG6155 P-SU Z

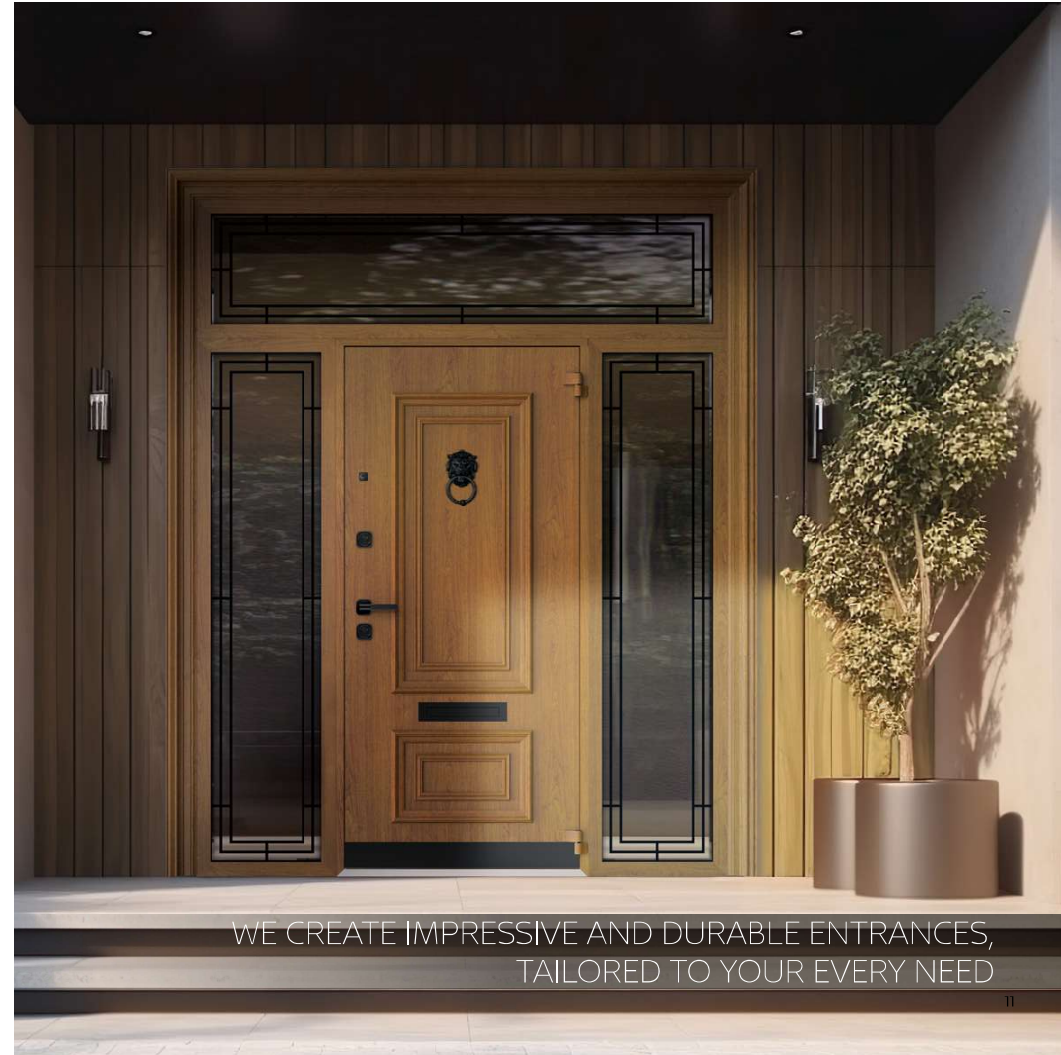

WE CREATE IMPRESSIVE AND DURABLE ENTRANCES,
TAILORED TO YOUR EVERY NEED



THE DURABLE ALUMINUM CONSTRUCTION

AG6044 P-SU



AG6144 P-SU



AG6149 P-SU



AG6045 P-SU



AG6020 P-SU



AG6070 P-SU



AG6101 P-SU



AG6156 P-SU



BURGLARY-RESISTANT FITTINGS
«CBA» WITH ARMORED PLATE



WE MANUFACTURE MODELS WITH «CBA» SMART LOCK

AG6133 P-SU



AG6145 P-SU



AG6016 P-SU



AG61133 Z P-SU



AG6015 P-SU



AG6046 P-SU



AG6131 P-SU



AG6019 P-SU



«CBA» SMART LOCK IS RESISTANT
TO TEMPERATURE CHANGES





HIGH SECURITY LEVEL FOR YOUR FAMILY

AG6079 P-SU



AG6146 P-SU



AG6018 P-SU



AG6147 P-SU



AG6057 SU

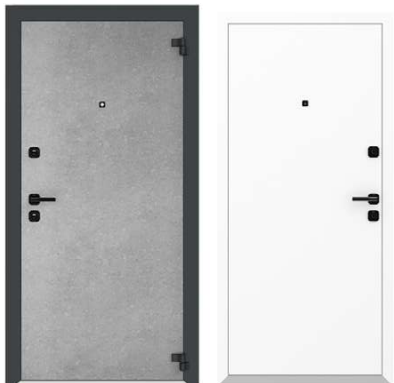

AG6010 P-SU



AG6082 SU



AG6107 SU



THE DOOR STRUCTURE IS COMPLETELY WELD-FREE



STAINLESS STEEL PULL-BAR HANDLES

AG6153 SU



AG6103 SU



AG6152 SU



AG6120 SU



AG6119 SU



AG6123 SU



AG6132 SU



AG6132 Z SU



ALL DECORATIVE ELEMENTS ARE MADE OF ALUMINUM



RICH COLOR PALETTE

AG6014 SU



AG6030 SU



AG6052 SU



AG6129 SU



AG6035 SU



AG6041 P-SU



THE DOORS ARE EXPOSED TO ADDITIONAL ANTI-CORROSION TREATMENT BEFORE PAINTING



WARM HOUSE IN ANY WEATHER

AG6083 SU



AG6068 SU



AG6067 SU



AG6122 SU



AG6039 SU



AG6117 SU



AG6125 SU



AG6154 SU

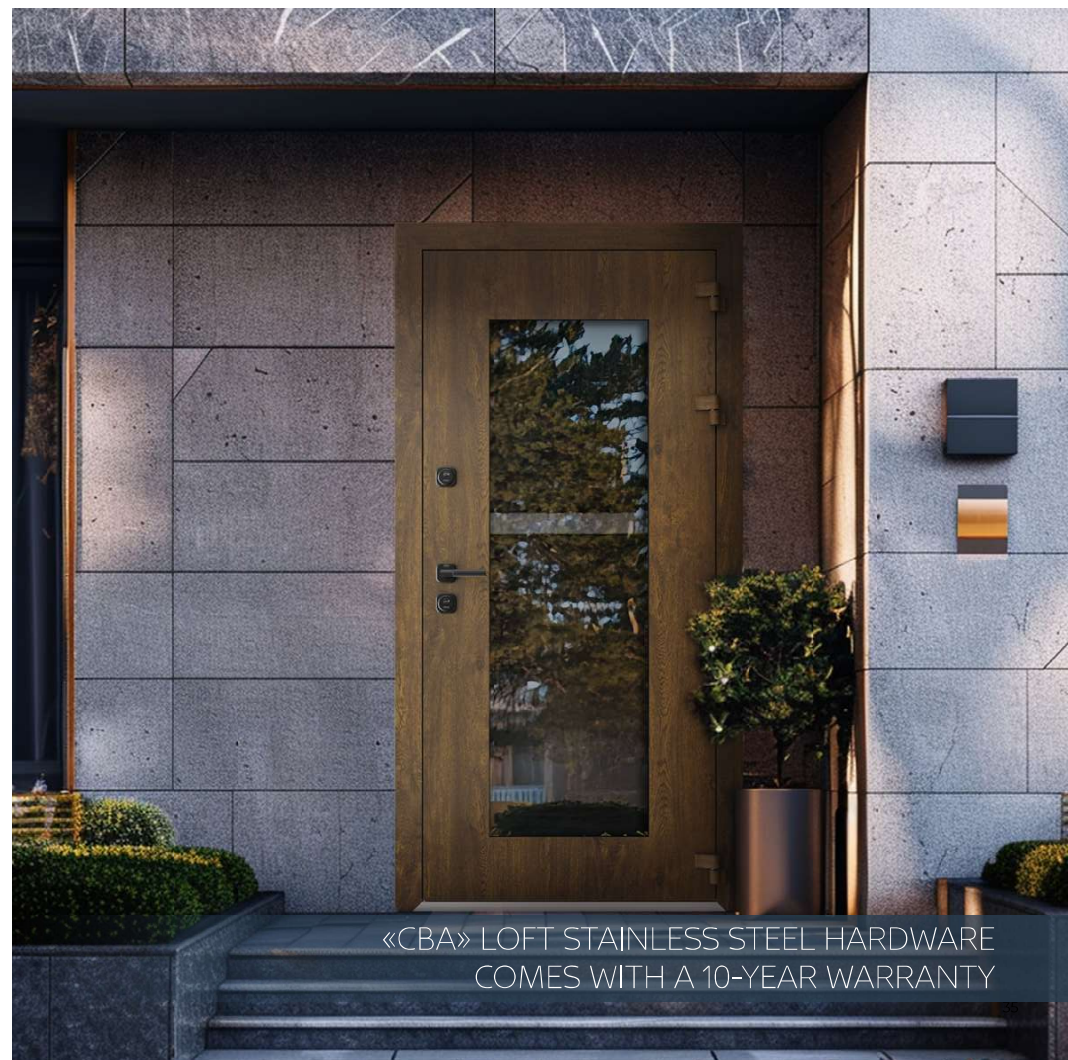

«CBA» LOFT STAINLESS STEEL HARDWARE
COMES WITH A 10-YEAR WARRANTY



THE NEW SYNONYM FOR WARMTH IN YOUR HOME

AG6139 SU



AG6116 SU



AG6118 SU



AG6115 SU



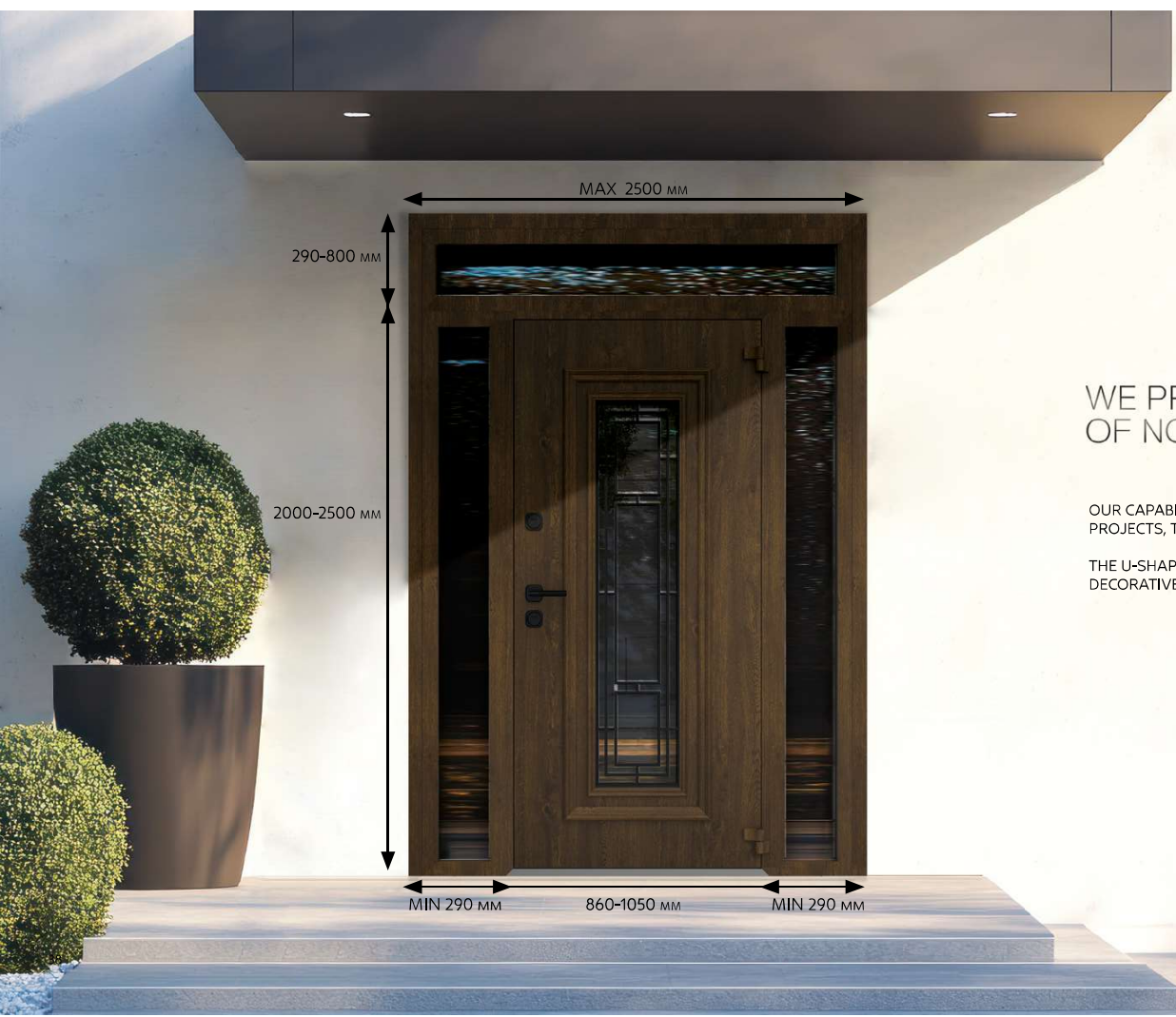

WE PRODUCE ENTRANCE GROUPS OF NON-STANDART DIMENSIONS

OUR CAPABILITIES ALLOW TO CREATE IMPRESSIVE AND DURABLE PROJECTS, TAKING INTO ACCOUNT ALL YOUR REQUIREMENTS!

THE U-SHAPED CAPITAL AND PANORAMIC GLAZING WITH AN INSERTED DECORATIVE LATTICE CAN BE ADDED TO ANY ENTRANCE GROUP.

CASINGS



SOLID CASING
(UP TO 2200 MM, OUTWARD OPENING ONLY)

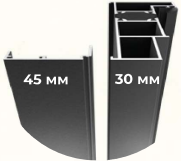

ATTACHED CASING

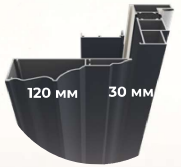

FIGURED CASING

SINGLE DOOR

ONE-AND-A-HALF DOOR



OUTWARD OPENING

INWARD OPENING

WITH A SOLID SIDE PANEL OUTWARD OPENING

WITH GLASS UNIT IN THE SIDE PANEL OUTWARD OPENING



OUTWARD OPENING

INWARD OPENING

OUTWARD OPENING

INWARD OPENING

AVAILABLE SIZES	
HEIGHT	WIDTH
2050 To 2500 MM 1800-2000 MM - IN CERTAIN MODELS (50 MM INCREMENTS)	860, 960, 1000, 1050 MM

AVAILABLE SIZES	
HEIGHT	WIDTH
2050 To 2200 MM 1800-2000 MM - IN CERTAIN MODELS (50 MM INCREMENTS)	1200 To 1800 MM (50 MM INCREMENTS)

CONSTRUCTION



1 4-CHAMBER GLASS UNIT USING TRIPLEX TECHNOLOGY



2 ANODIZED ALUMINUM FRAME AND METAL DOOR LEAF WITH THERMAL BREAK



3 STAINLESS STEEL INSERTS



4 STAINLESS STEEL INSERTS



5 DOUBLE SEALING FOR DOOR LEAF AND FRAME



6 DECORATIVE ALUMINUM SLATS



7 TWO-TONE FINISH FOR DOOR FRAME AND DOOR LEAF



8 TWO-SECTION OVERHEAD HINGES WITH 3D ADJUSTMENT



9 RELIABLE «CBA» LOCKING SYSTEM AND CYLINDER



10 STAINLESS STEEL HARDWARE SET «CBA» LOFT

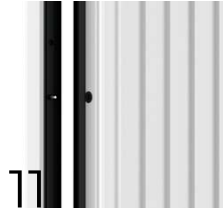

11 ANTI-THEFT BOLTS 16 MM IN DIAMETER (3 PCS.) FOR BURGLAR PROTECTION



12 ALUMINUM THRESHOLD WITH THERMAL BREAK IS RESISTANT TO CORROSION AND MECHANICAL IMPACTS

THERMAL BREAK



DOOR FRAME

THE FRAME IS MADE OF ANODIZED ALUMINUM. THE OUTER AND INNER PARTS OF THE FRAME ARE CONNECTED BY A 36 MM THICK POLYAMIDE INSERT (THERMAL BREAK), ENSURING MAXIMUM THERMAL INSULATION.

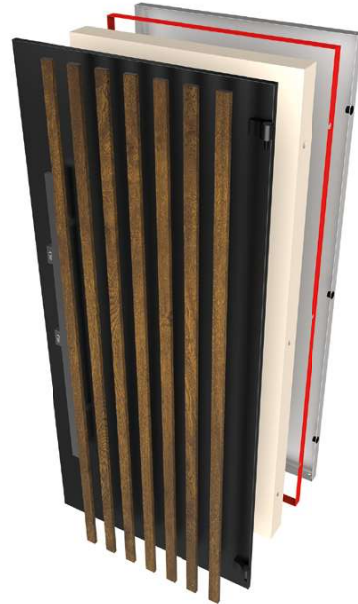

DOOR LEAF

THE DOOR LEAF WITH THERMAL BREAK IS MADE OF TWO SHEETS OF 1.2 MM THICK GALVANIZED STEEL. THE THREE-CIRCUIT DESIGN WITH EXPANDED POLYSTYRENE FOAM CORE GUARANTEES EXCELLENT HEAT AND SOUND INSULATION, RELIABILITY, AND DURABILITY.



SEALING SYSTEM

TWO SEALING CIRCUITS ON THE DOOR LEAF AND FRAME RETAIN THE HEAT IN YOUR HOME. THE SEALING SYSTEM ENSURES A RELIABLE DOOR SEAL, RESISTS DEFORMATION, AND DOES NOT ACCUMULATE MOISTURE.

SURFACE-MOUNTED HINGES

HINGES WITH 3D ADJUSTMENT ARE MADE OF ALUMINUM ALLOY, FEATURE A GALVANIZED STEEL PIN, CE QUALITY CERTIFICATES, AND ROSENHEIM (GERMANY) TEST REPORTS.

3D HINGES:

- DISTRIBUTE THE LOAD ON THE DOOR FRAME AND PREVENT DOOR LEAF DISTORTION
- ADJUST PLAY AND SMOOTH DOOR OPENING/CLOSING
- GUARANTEE LONG-LASTING OPERATION, QUIET, AND SMOOTH DOOR OPENING

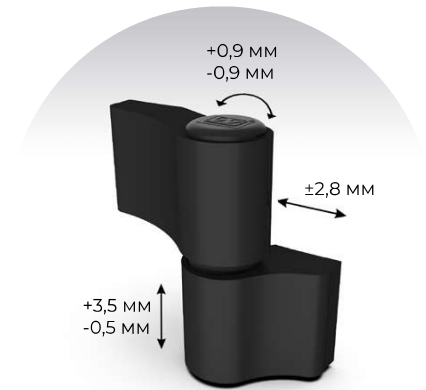

DECOLUX FINISH

DECOLUX FINISH (PAINT) IS A VIBRANT AND DURABLE DESIGN, **STYLIZED TO RESEMBLE THE TEXTURE OF WOOD OR STONE**. THIS FINISH IS CREATED THROUGH A MULTI-STAGE PROCESS CARRIED OUT ON AN AUTOMATED CONVEYOR LINE, ALLOWING FOR THE TRANSFER OF DETAILED IMAGES ONTO A METAL SURFACE.

ADVANTAGES:

- OUR PROPRIETARY, UNIQUE DEVELOPMENT
- THE COATING IS RESISTANT TO CORROSION, TEMPERATURE FLUCTUATIONS, SALT FOG, AND UV RADIATION, AND DOES NOT CRACK OR PEEL.
- REMAINS CONSISTENTLY COLORFUL FOR MANY YEARS.
- 10-YEAR WARRANTY

FINISH OPTIONS:

- FULL DECOLUX FINISH
- SLATS IN DECOLUX FINISH
- INSERTS IN DECOLUX FINISH

COLOR PALETTE



AMERICAN WALNUT



LIGHT TEAK



DARK TEAK*



DARK OAK*



LIGHT CONCRETE



CONCRETE



DARK CONCRETE*

* FULL DECOLUX FINISH IS ONLY AVAILABLE IN DARK TEAK, DARK OAK, AND DARK CONCRETE.



POLIMEX FINISH

POLIMEX FINISH IS A SPECIAL POLYMER PAINT APPLIED TO METAL SURFACES ON BOTH SIDES USING AN ITALIAN-MADE AUTOMATIC CONVEYOR LINE.

- RESISTANCE TO MECHANICAL DAMAGE
- CORROSION-RESISTANT, CRACK-RESISTANT, AND PEEL-RESISTANT
- PERFECTLY SMOOTH SURFACE WITHOUT DRIPS OR UNEVEN COLOR
- LESS SUSCEPTIBLE TO FADING AND UV DAMAGE
- MAINTAINS RICH COLOR AND SHINE FOR YEARS
- WIDE COLOR PALETTE: FROM CLASSIC TO VIBRANT ACCENT SHADES

COLOR PALETTE



COLOR PALETTE



WHITE



IVORY

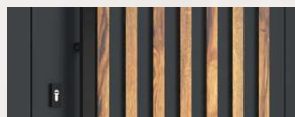

AMERICAN WALNUT

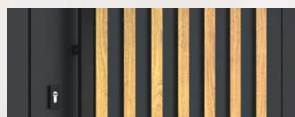

LIGHT TEAK

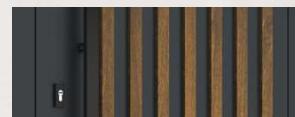

DARK OAK*



LIGHT CONCRETE



GLASS UNIT USING TRIPLEX TECHNOLOGY

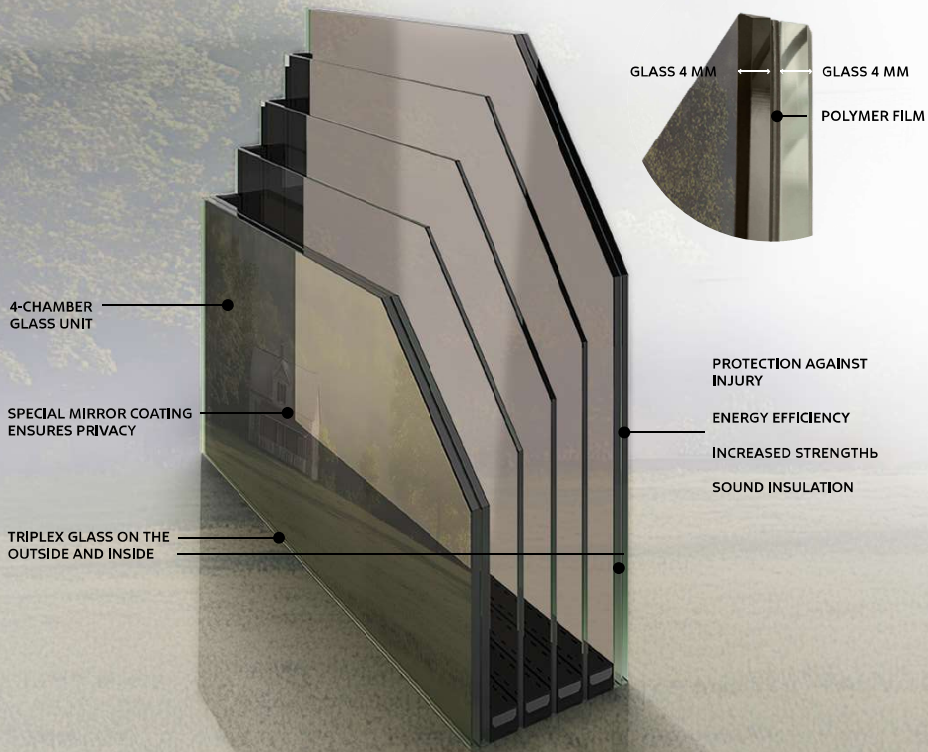

GLASS UNITS PALETTE



BRONZE



BRONZE WITH BLACK LATTICE



CHROME



CHROME WITH BLACK LATTICE



SATIN



GRAPHITE





«CBA» STAINLESS STEEL HARDWARE

LEVER-HANDLES



«LOFT»
BLACK



«LOFT»
BRONZE



«LOFT»
STAINLESS STEEL



«LOFT»
GOLD



PULL-BAR HANDLES

BURGLAR-RESISTANT FEATURES

SLEEK DESIGN

CORROSION PROTECTION

10-YEAR WARRANTY



PULL-BAR HANDLES
«LOFT»
BLACK
1200 MM, 1800 MM



PULL-BAR HANDLES
«VEGA»
STAINLESS STEEL
1200 MM, 1800 MM



PULL-BAR HANDLES
«VEGA»
BLACK
1200 MM, 1800 MM



«CBA» LOCKING SYSTEM 4TH CLASS OF BURGLARU RESISTANCE



DURABLE STEEL BODY WITH A GALVANIZED COATING

8 SOLID DEADBOLTS (14 MM IN DIAMETER)

STAINLESS STEEL BAR AND LATCH

2 «CBA» CYLINDERS WITH A THERMAL ROD

EACH CYLINDER COMES WITH 7 KEYS

CORROSION-RESISTANT, IMPERVIOUS TO DRAFTS AND FREEZES

QUIET AND SMOOTH OPERATION

KEYHOLE IS NOT VISIBLE

SMART LOCK «CBA»



MAIN CAMERA.
FACE ID SCANNER WITH
INFRARED BACKLIGHTING
(SCANS IN THE DARK)



WATERPROOF
ALUMINUM CASE,
BOARD IS ADDITIONALLY
COATED WITH A SPECIAL
COMPOUND



MECHANICAL KEY SLOT/USB
PORT, FINGERPRINT SCANNER



VIDEO-PEEPHOLE WITH
MICROPHONE ALLOWS YOU
TO VIEW AND TALK TO THE
GUEST AND OPEN THE DOOR
FROM ANYWHERE IN THE
WORLD



TURNING HANDLE FOR
OPENING THE DOOR FROM
THE INSIDE



NIGHT LATCH,
LOCK/UNLOCK BUTTONS



OPENING METHODS



FACE ID



APP
USMART GO



FINGERPRINT



SMART CARD



PASSCODE



MECHANICAL KEY

SECURITY AT A NEW LEVEL

«CBA» SMART LOCK SYSTEM:

7 SOLID DEADBOLTS WITH 17 MM DIAMETER

NIGHT LATCH

PLATE, DEADBOLTS, NIGHT LATCH AND DETENT ARE MADE OF STAINLESS STEEL

HIGH BURGLARY RESISTANCE

ADDITIONAL «CBA» TOP LOCK:

CYLINDER MECHANISM WITH THERMAL ROD

3 SOLID DEADBOLTS WITH 17 MM DIAMETER

PLATE AND DEADBOLTS ARE MADE OF STAINLESS STEEL

4TH CLASS BURGLARY RESISTANCE

ADVANTAGES OF USE:

WIDE TEMPERATURE RANGE: FROM -30 TO +60°C

6000 MAH BATTERY (5-6 MONTHS OF CONTINUOUS OPERATION)

AUTOMATIC DEADBOLT LOCKING FUNCTION IS AVAILABLE

FULL CONTROL AND MANAGEMENT VIA THE USMART GO APP FROM ANYWHERE IN THE WORLD

SECURITY FOR THE WHOLE FAMILY

