

A black and white photograph of a sandy beach. The sand is light-colored and shows numerous footprints and small, dark objects scattered across the surface. The lighting creates soft shadows, highlighting the texture of the sand and the depth of the tracks. The overall scene is a natural, outdoor setting.

BOSTON COLLECTION



THE WARMTH YOU FEEL

WARM ALUMINUM CONSTRUCTION

PROTECTION AGAINST DRAFTS, FREEZING, AND CONDENSATION

ENERGY-EFFICIENT TRIPLEX GLASS UNITS

ENERGY-EFFICIENT TRIPLEX GLASS UNITS

THE RELIABILITY YOU NEED

ALUMINUM CAN WITHSTAND HIGH LOADS AND RESIST DEFORMATION

THE FINISH RETAINS ITS ORIGINAL APPEARANCE FOR MANY YEARS

SHOCKPROOF TRIPLEX GLASS UNITS

DOORS WITHSTAND HEAVY LOADS AND RESIST DEFORMATION



A modern building with a dark gray, minimalist facade. The entrance features a set of dark gray double doors with vertical glass inserts. To the right, a large window wall reflects the surrounding greenery. The foreground shows a dark gray concrete walkway and steps leading to the entrance, flanked by manicured green bushes. The background consists of a dense forest of tall trees under a bright sky.

STANDS FOR IMPRESSIVE DURABILITY

RELIABLE ALUMINUM CONSTRUCTION IS RESISTANT TO INTENSIVE USE AND TEMPERATURE FLUCTUATIONS

POLIMEX AND DECOLUX FINISHES COME WITH A 10-YEAR WARRANTY

THOUGHT-OUT CONSTRUCTION IS BASED ON MANY YEARS OF OUR EXPERIENCE

STAINLESS STEEL HARDWARE COMES WITH A 10-YEAR WARRANTY

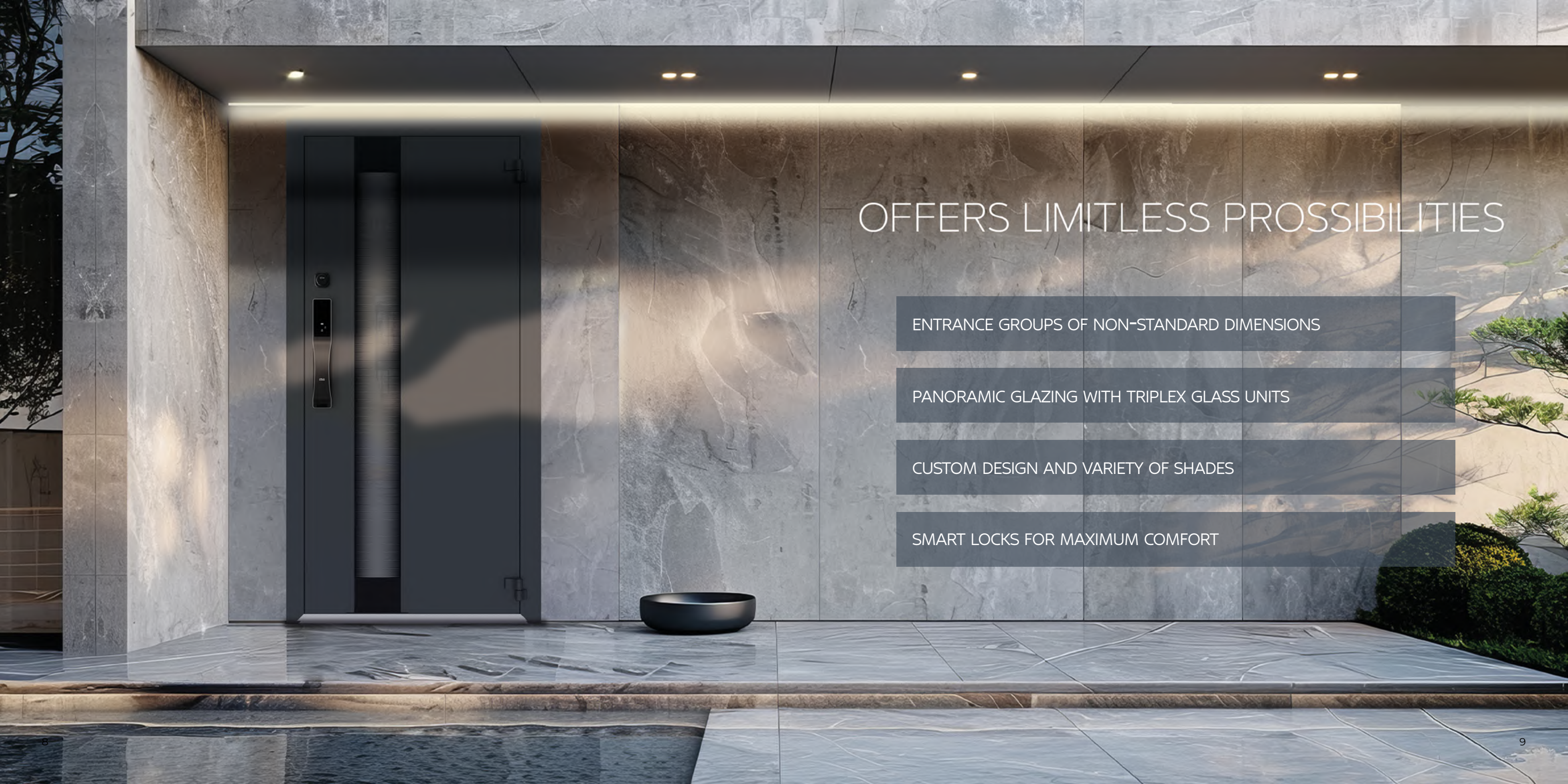

OFFERS LIMITLESS POSSIBILITIES

ENTRANCE GROUPS OF NON-STANDARD DIMENSIONS

PANORAMIC GLAZING WITH TRIPLEX GLASS UNITS

CUSTOM DESIGN AND VARIETY OF SHADES

SMART LOCKS FOR MAXIMUM COMFORT

AG6145



AG6003



AG6146



AG6155



THE DURABLE ALUMINUM CONSTRUCTION



WE CREATE IMPRESSIVE AND DURABLE ENTRANCES
TAILORED TO YOUR EVERY NEED

AG6044



AG6144



AG6149



AG6045



AG6020



AG6002



AG6021



AG6018



BURGLARY-RESISTANT FITTINGS «CBA» WITH ARMORED PLATE



WE MANUFACTURE MODELS WITH «CBA» SMART LOCK

AG6025



AG6027



AG6155 Z



AG6096



AG6147



AG6131



«CBA» SMART LOCK IS RESISTANT TO TEMPERATURE CHANGES





WE MANUFACTURE PANORAMIC GLAZING
WITH INSERTED DECORATIVE LATTICE

AG6133 Z



AG6077



AG6156



AG6133



AG6026



AG6016



AG6017



AG6019



ALL DECORATIVE ELEMENTS
ARE MADE OF ALUMINUM

WARM HOUSE IN ANY WEATHER



AG6020



AG6015



AG6048



AG6120



HIGH SECURITY LEVEL FOR YOUR FAMILY

«CBA» LOFT STAINLESS STEEL HARDWARE
COMES WITH A 10-YEAR WARRANTY



AG6057

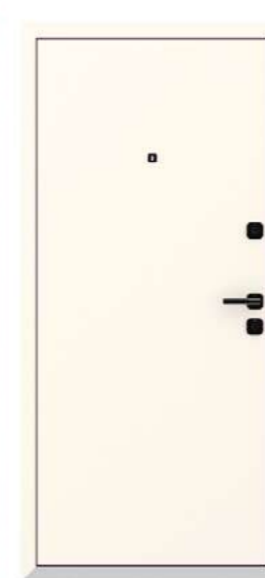

AG6010



AG6039



AG6067



AG6052



AG6066



AG6154



AG6041



THE DOOR STRUCTURE IS COMPLETELY WELD-FREE

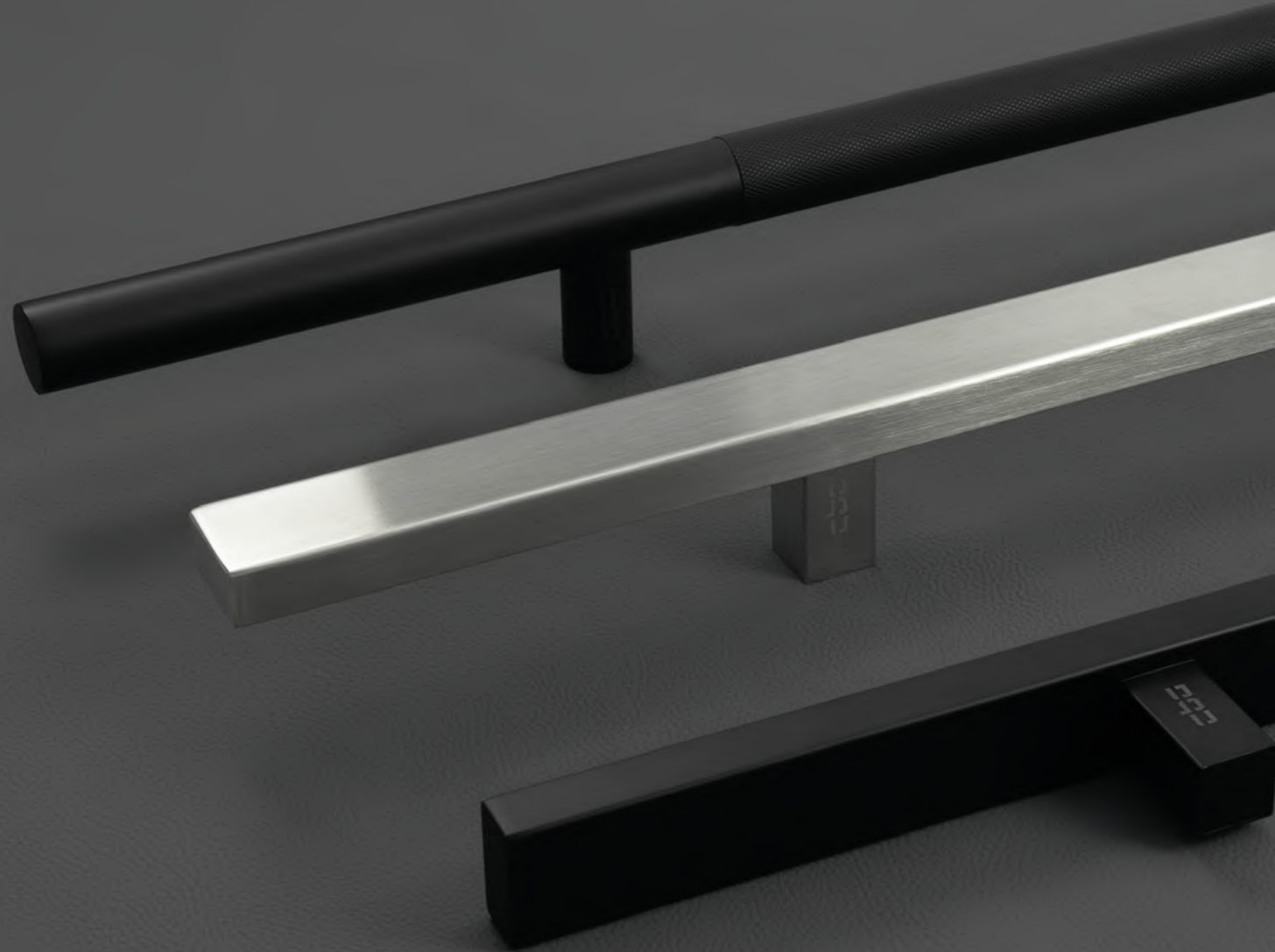

STAINLESS STEEL PULL-BAR HANDLES

AG6119



AG6034



AG6035



AG6132



AG6103

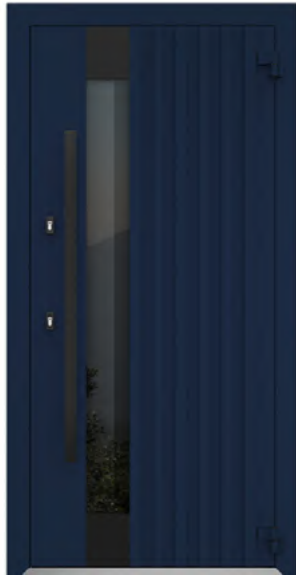

AG6123

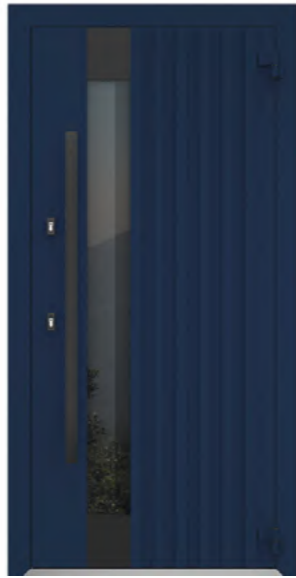

AG6122



AG6132 Z



RICH COLOR PALETTE



THE NEW SYNONYM
FOR WARMTH IN YOUR HOME

AG6033



AG6107



AG6050



AG6030





MAX 2500 mm

290-800 mm

2000-2500 mm

MIN 290 mm

860-1050 mm

MIN 290 mm

WE PRODUCE ENTRANCE GROUPS OF NON-STANDART DIMENSIONS

OUR CAPABILITIES ALLOW TO CREATE IMPRESSIVE AND DURABLE PROJECTS, TAKING INTO ACCOUNT ALL YOUR REQUIREMENTS!

THE U-SHAPED CAPITAL AND PANORAMIC GLAZING WITH AN INSERTED DECORATIVE LATICE CAN BE ADDED TO ANY ENTRANCE GROUP.

CASINGS



SOLID CASING
(UP TO 2200 MM, OUTWARD OPENING ONLY)

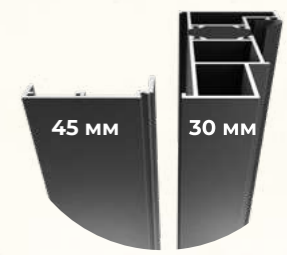

ATTACHED CASING

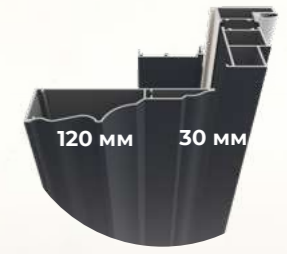

FIGURED CASING

SINGLE DOOR

ONE-AND-A-HALF DOOR



OUTWARD OPENING

INWARD OPENING

WITH A SOLID SIDE PANEL OUTWARD OPENING

WITH GLASS UNIT IN THE SIDE PANEL OUTWARD OPENING



OUTWARD OPENING

INWARD OPENING

OUTWARD OPENING

INWARD OPENING

AVAILABLE SIZES	
HEIGHT	WIDTH
2050 TO 2500 MM 1800-2000 MM - IN CERTAIN MODELS (50 MM INCREMENTS)	860, 960, 1000, 1050 MM

AVAILABLE SIZES	
HEIGHT	WIDTH
2050 TO 2200 MM 1800-2000 MM - IN CERTAIN MODELS (50 MM INCREMENTS)	1200 TO 1800 MM (50 MM INCREMENTS)

CONSTRUCTION



1 THE DOOR LEAF IS MADE OF 2 SHEETS OF GALVANIZED STEEL WITH A WEATHER-RESISTANT COATING



2 ANODIZED ALUMINUM FRAME AND METAL DOOR LEAF WITH THERMAL BREAK



3 DECORATIVE ALUMINUM CAPITAL



4 STAINLESS STEEL INSERTS



5 DOUBLE SEALING FOR DOOR LEAF AND FRAME



6 DECORATIVE ALUMINUM GLAZING BEAD



7 TWO-TONE FINISH FOR DOOR FRAME AND DOOR LEAF



8 TWO-SECTION OVERHEAD HINGES WITH 3D ADJUSTMENT



9 RELIABLE «CBA» LOCKING SYSTEM AND CYLINDER



10 STAINLESS STEEL HARDWARE SET «CBA» LOFT



11 ANTI-THEFT BOLTS 16 MM IN DIAMETER (3 PCS.) FOR BURGLAR PROTECTION



12 ALUMINUM THRESHOLD WITH THERMAL BREAK IS RESISTANT TO CORROSION AND MECHANICAL IMPACTS

THERMAL BREAK



DOOR FRAME

THE FRAME IS MADE OF ANODIZED ALUMINUM. THE OUTER AND INNER PARTS OF THE FRAME ARE CONNECTED BY A 36 MM THICK POLYAMIDE INSERT (THERMAL BREAK), ENSURING MAXIMUM THERMAL INSULATION.



DOOR LEAF

THE DOOR LEAF WITH THERMAL BREAK IS MADE OF TWO SHEETS OF 1.2 MM THICK GALVANIZED STEEL. THE THREE-CIRCUIT DESIGN WITH EXPANDED POLYSTYRENE FOAM CORE GUARANTEES EXCELLENT HEAT AND SOUND INSULATION, RELIABILITY, AND DURABILITY.



SEALING SYSTEM

TWO SEALING CIRCUITS ON THE DOOR LEAF AND FRAME RETAIN THE HEAT IN YOUR HOME. THE SEALING SYSTEM ENSURES A RELIABLE DOOR SEAL, RESISTS DEFORMATION, AND DOES NOT ACCUMULATE MOISTURE.

SURFACE-MOUNTED HINGES

HINGES WITH 3D ADJUSTMENT ARE MADE OF ALUMINUM ALLOY, FEATURE A GALVANIZED STEEL PIN, CE QUALITY CERTIFICATES, AND ROSENHEIM (GERMANY) TEST REPORTS.

3D HINGES:

- DISTRIBUTE THE LOAD ON THE DOOR FRAME AND PREVENT DOOR LEAF DISTORTION
- ADJUST PLAY AND SMOOTH DOOR OPENING/CLOSING
- GUARANTEE LONG-LASTING OPERATION, QUIET, AND SMOOTH DOOR OPENING

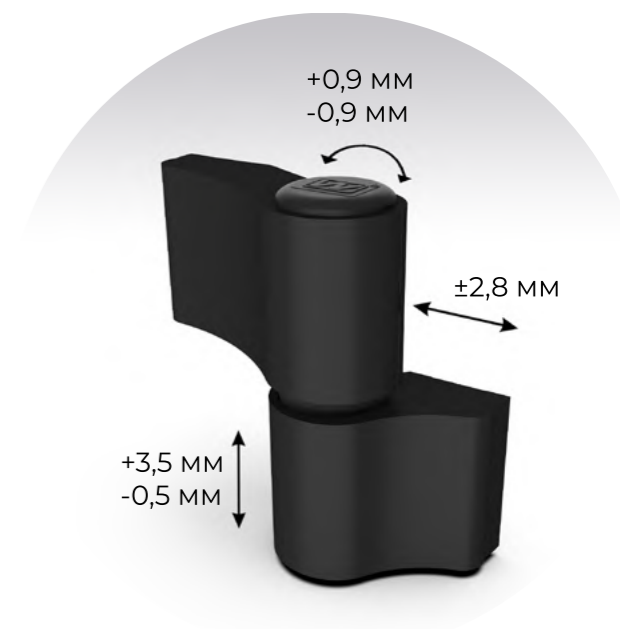

POLIMEX FINISH

POLIMEX FINISH IS A SPECIAL POLYMER PAINT APPLIED TO METAL SURFACES ON BOTH SIDES USING AN ITALIAN-MADE AUTOMATIC CONVEYOR LINE.

- RESISTANCE TO MECHANICAL DAMAGE
- CORROSION-RESISTANT, CRACK-RESISTANT, AND PEEL-RESISTANT
- PERFECTLY SMOOTH SURFACE WITHOUT DRIPS OR UNEVEN COLOR
- LESS SUSCEPTIBLE TO FADING AND UV DAMAGE
- MAINTAINS RICH COLOR AND SHINE FOR YEARS
- WIDE COLOR PALETTE: FROM CLASSIC TO VIBRANT ACCENT SHADES

COLOR PALETTE

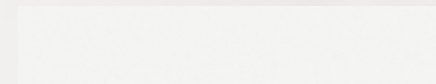

WHITE



IVORY

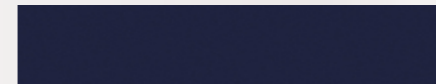

SHIMMERING MIDNIGHT



CRIMSON RUBY

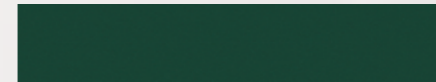

RICH EMERALD

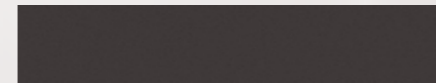

BITTER CHOCOLATE

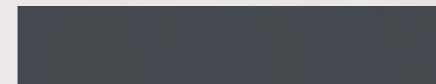

GRAPHITE

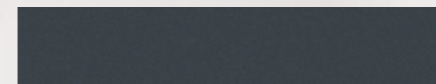

ANTHRACITE



ONYX



GLASS UNIT USING TRIPLEX TECHNOLOGY

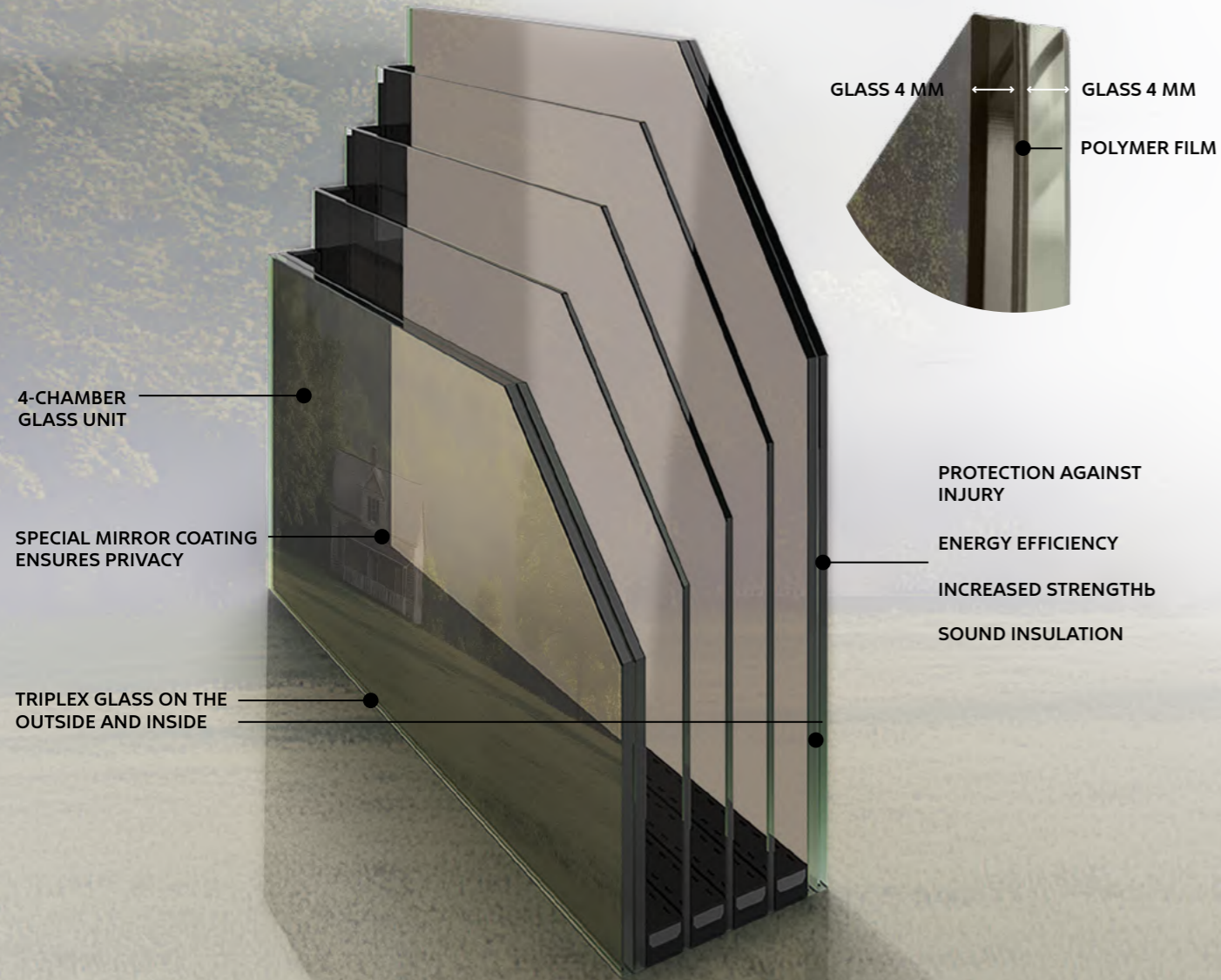

GLASS UNITS PALETTE



BRONZE



BRONZE WITH BLACK LATTICE

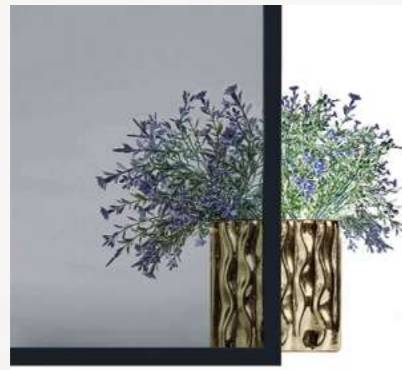

CHROME

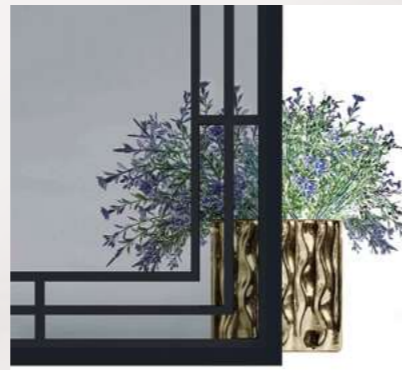

CHROME WITH BLACK LATTICE



SATIN



GRAPHITE





«CBA» STAINLESS STEEL HARDWARE

LEVER-HANDLES



«LOFT»
BLACK

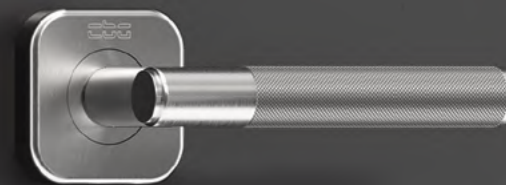

«LOFT»
STAINLESS STEEL



«LOFT»
BRONZE



«LOFT»
GOLD

PULL-BAR HANDLES

BURGLAR-RESISTANT FEATURES

SLEEK DESIGN

CORROSION PROTECTION

10-YEAR WARRANTY

PULL-BAR HANDLES
«LOFT»
BLACK
1200 MM, 1800 MM

PULL-BAR HANDLES
«VEGA»
STAINLESS STEEL
1200 MM, 1800 MM

PULL-BAR HANDLES
«VEGA»
BLACK
1200 MM, 1800 MM

«CBA» LOCKING SYSTEM 4TH CLASS OF BURGLARU RESISTANCE



DURABLE STEEL BODY WITH A GALVANIZED COATING

8 SOLID DEADBOLTS (14 MM IN DIAMETER)

STAINLESS STEEL BAR AND LATCH

2 «CBA» CYLINDERS WITH A THERMAL ROD

EACH CYLINDER COMES WITH 7 KEYS

CORROSION-RESISTANT, IMPERVIOUS TO DRAFTS AND FREEZES

QUIET AND SMOOTH OPERATION

KEYHOLE IS NOT VISIBLE

SMART LOCK «CBA»



MAIN CAMERA.
FACE ID SCANNER WITH
INFRARED BACKLIGHTING
(SCANS IN THE DARK)

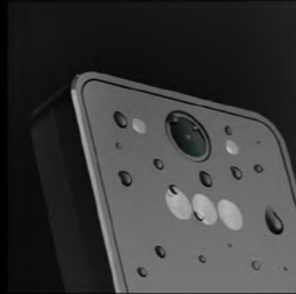

WATERPROOF
ALUMINUM CASE,
BOARD IS ADDITIONALLY
COATED WITH A SPECIAL
COMPOUND



MECHANICAL KEY SLOT/USB
PORT, FINGERPRINT SCANNER



VIDEO-PEEPHOLE WITH
MICROPHONE ALLOWS YOU
TO VIEW AND TALK TO THE
GUEST AND OPEN THE DOOR
FROM ANYWHERE IN THE
WORLD



TURNING HANDLE FOR
OPENING THE DOOR FROM
THE INSIDE



NIGHT LATCH,
LOCK/UNLOCK BUTTONS



OPENING METHODS

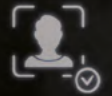

FACE ID



APP
USMART GO



FINGERPRINT



SMART CARD

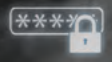

PASSCODE

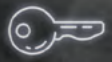

MECHANICAL KEY

SECURITY AT A NEW LEVEL

«CBA» SMART LOCK SYSTEM:

7 SOLID DEADBOLTS WITH 17 MM DIAMETER

NIGHT LATCH

PLATE, DEADBOLTS, NIGHT LATCH AND DETENT ARE MADE OF STAINLESS STEEL

HIGH BURGLARY RESISTANCE

ADDITIONAL «CBA» TOP LOCK:

CYLINDER MECHANISM WITH THERMAL ROD

3 SOLID DEADBOLTS WITH 17 MM DIAMETER

PLATE AND DEADBOLTS ARE MADE OF STAINLESS STEEL

4TH CLASS BURGLARY RESISTANCE

ADVANTAGES OF USE:

WIDE TEMPERATURE RANGE: FROM -30 TO +60°C

6000 MAH BATTERY (5-6 MONTHS OF CONTINUOUS OPERATION)

AUTOMATIC DEADBOLT LOCKING FUNCTION IS AVAILABLE

FULL CONTROL AND MANAGEMENT VIA THE USMART GO APP FROM ANYWHERE IN THE WORLD

SECURITY FOR THE WHOLE FAMILY

